

KUP-161

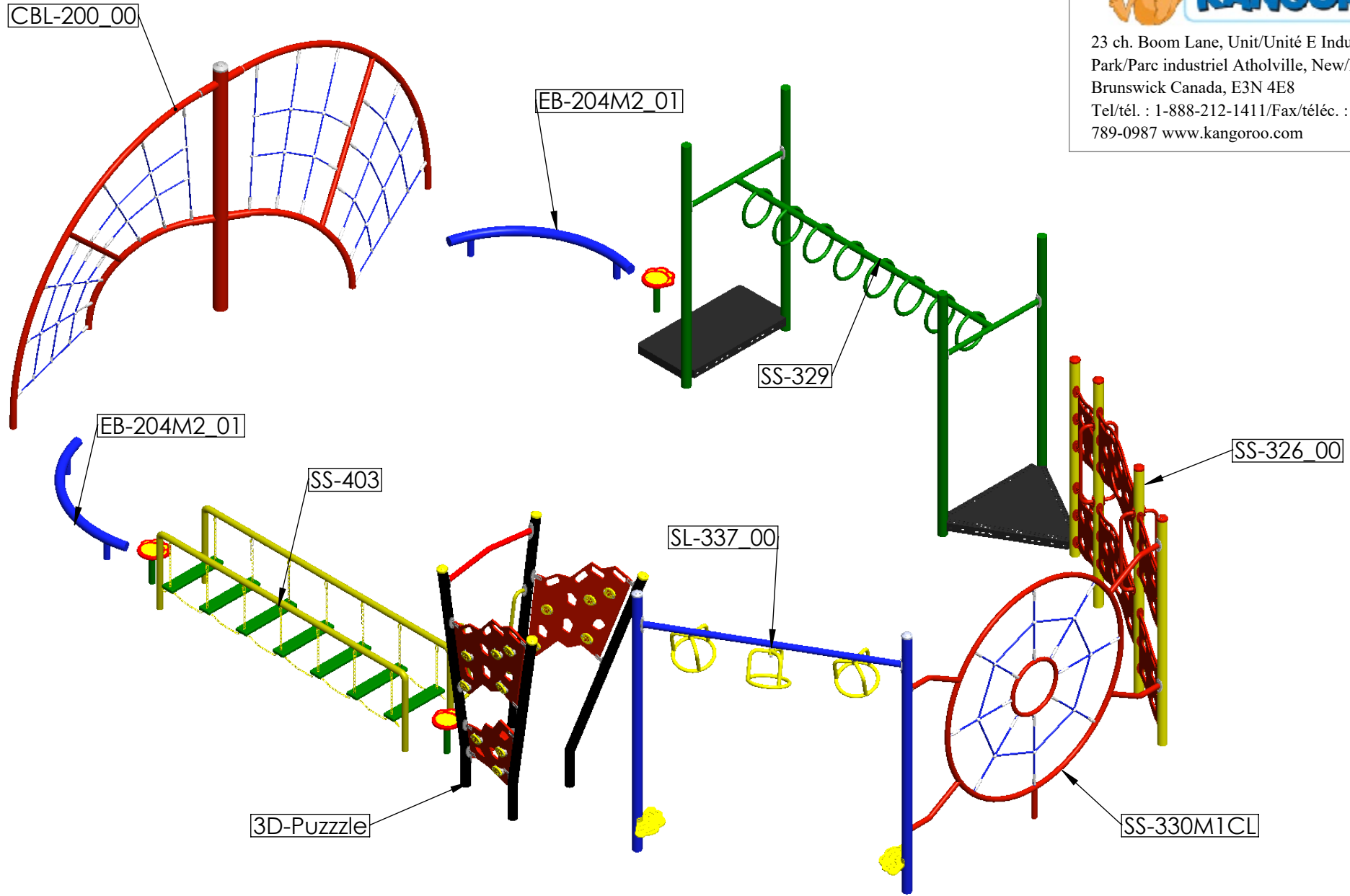

23 ch. Boom Lane, Unit/Unité E Industrial
 Park/Parc industriel Atholville, New/Nouveau-
 Brunswick Canada, E3N 4E8
 Tel/tél. : 1-888-212-1411/Fax/télé. : 1-888-
 789-0987 www.kangaroo.com



Kup-161

Min. Protective Surface Required / Surface de protection min. requise
 . m ("") x .m ("")

Equipment Dimensions / Dimensions de l'équipement :
 10.48m (34'-4.6") x 6.5m (21'-3.5")

Approval date: 2021-02-26

CAN/CSA-Z614

Recommended Ages / Âges recommandés :
 5 years to 12 years old / 5 ans à 12 ans

Capacity / Peut accueillir : up to children / Jusqu'à enfants

Rev: 00

Initial: S.T



23 ch. Boom Lane, Unit/Unité E Industrial
 Park/Parc industriel Atholville, New/Nouveau-
 Brunswick Canada, E3N 4E8
 Tel/tél. : 1-888-212-1411/Fax/télec. : 1-888-
 789-0987 www.kangaroo.com

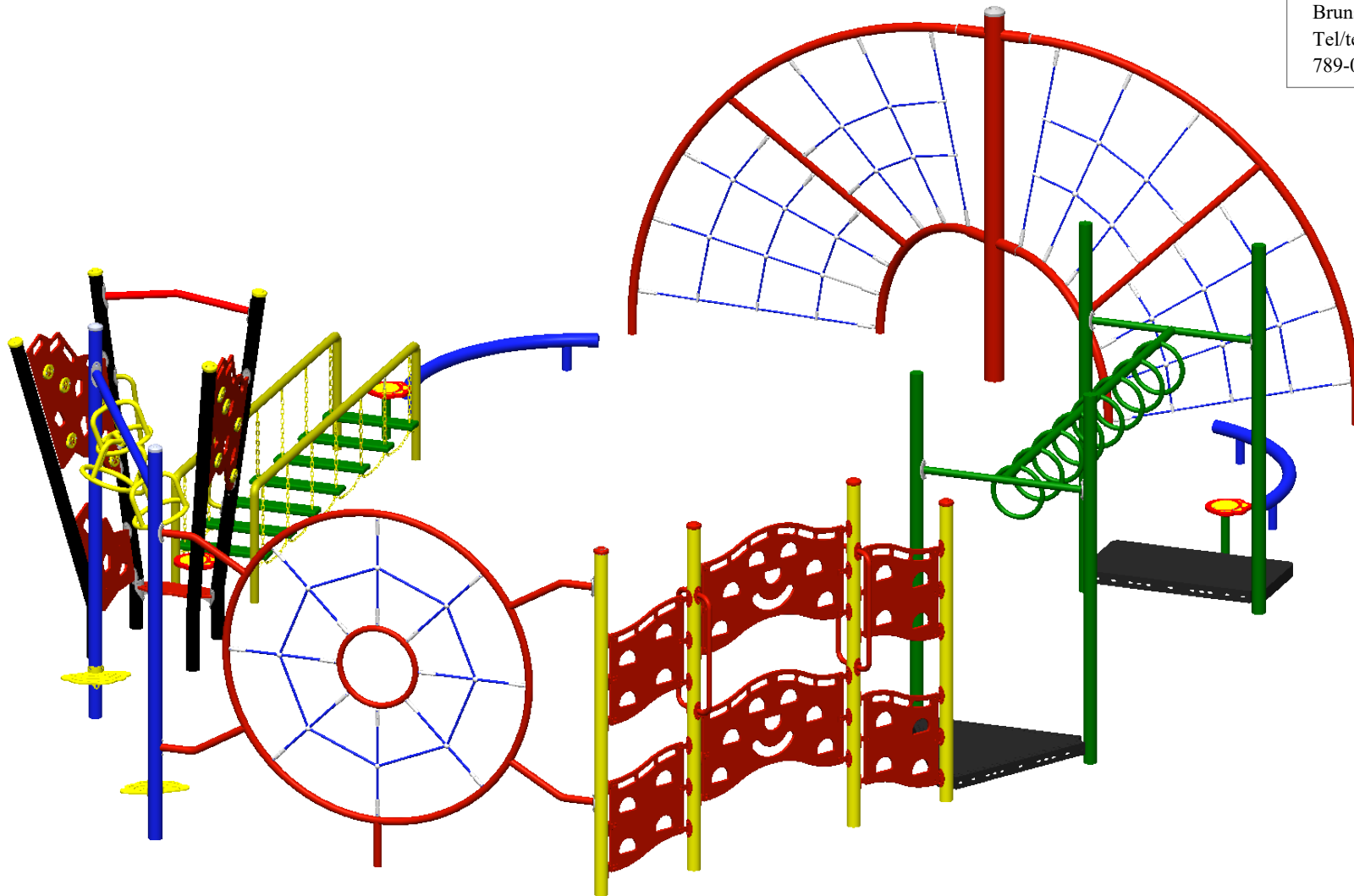

Kup-161

Min. Protective Surface Required / Surface de protection min. requise
 . m ("") x .m ("")

Equipment Dimensions / Dimensions de l'équipement :
 10.48m (34'-4.6") x 6.5m (21'-3.5")

Approval date: 2021-02-26

CAN/CSA-Z614

Recommended Ages / Âges recommandés :
 5 years to 12 years old / 5 ans à 12 ans

Capacity / Peut accueillir : up to children / Jusqu'à enfants

Rev: 00

Initial: S.T

KUP-161





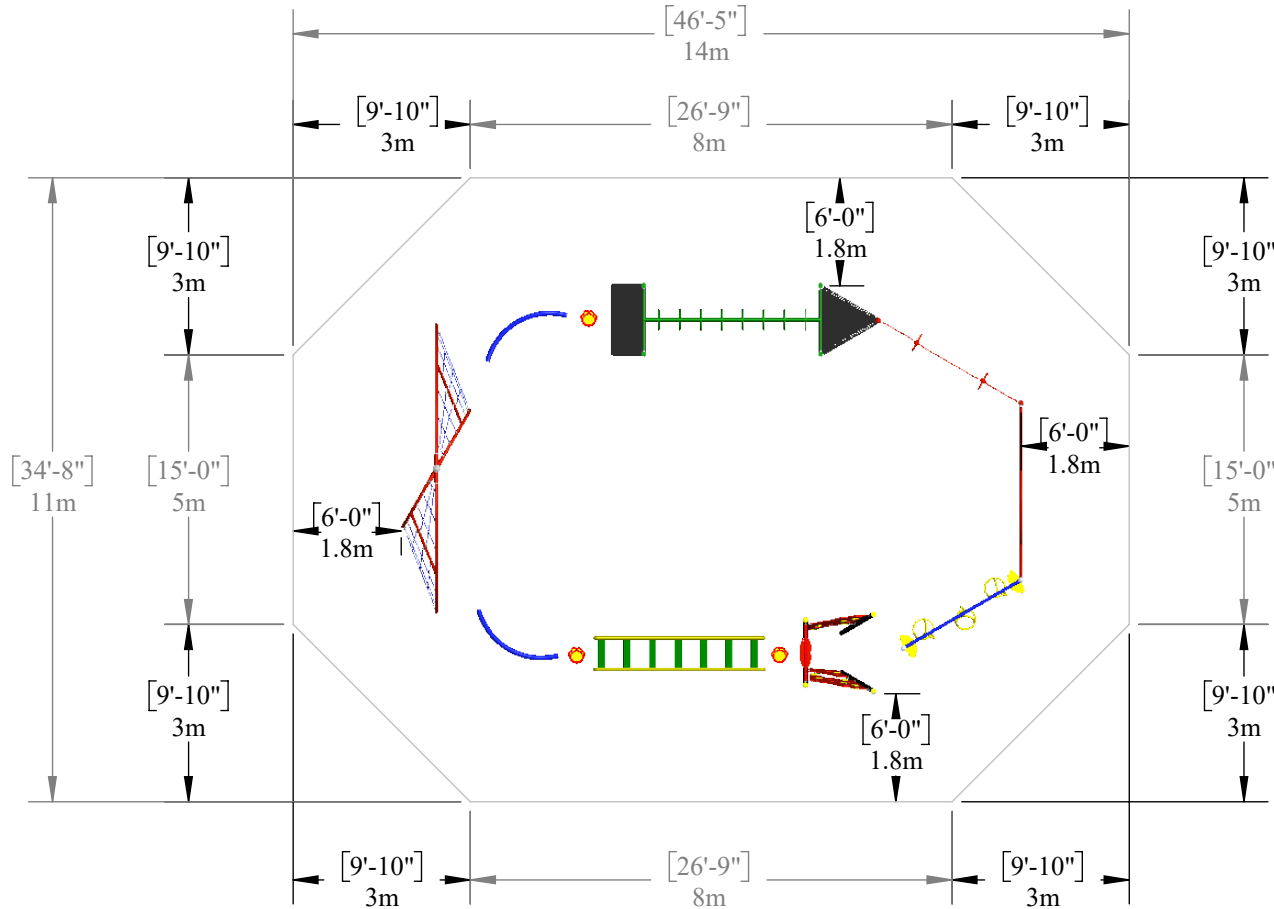

23 ch. Boom Lane, Unit/Unité E Industrial Park/Parc industriel
Atholville, New/Nouveau-Brunswick Canada, E3N 4E8
Tel/tél. : 1-888-212-1411/Fax/télec. : 1-888-789-0987
www.kangoroo.com

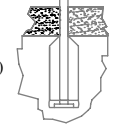
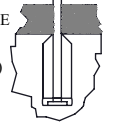

PLATFORM HEIGHTS
HAUTEURS DE PLATEFORME

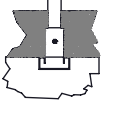
12" = 305MM	24" = 609MM
36" = 915MM	48" = 1219MM
60" = 1524MM	72" = 1829MM
84" = 2134MM	96" = 2438MM

<p>ZONE DE PROTECTION: Chaque équipement doit avoir une zone de protection constituée d'une surface sans obstacle qui se prolonge dans toutes les directions à partir du périmètre de l'équipement. Cette zone doit contenir un revêtement de surface (gravillon, sable, etc...) avec une capacité d'amortissement selon les normes CSA-Z614. Sauf avis contraire. Zone de protection minimum requise: 11m (34'-5") x 14 m (46'-5") - Surface: 154 sq. m (1657.64 sq. ft.) - Perimeter: 50m (164'-1")</p>	<p>PROTECTIVE SURFACING ZONE : Each equipment shall have a protective surfacing zone that consist of obstacle-free surfacing surrounding the equipment. This zone shall contain shock absorbing material (pea gravel, sand, etc...) that comply with CSA-Z614. Unless noted otherwise. Minimum Protective Surfacing Zone required: 11m (34'-5") x 14 m (46'-5") - Surface: 154 sq. m (1657.64 sq. ft.) - Perimeter: 50m (164'-1")</p>
<p>MÉTHODES D'INSTALLATION ① DANS LE BÉTON: - Quantité de Sonotube de 12" Ø x 12' :6 Béton: -3.0m.cu. (3.9vge.cu.)</p> 	<p>INSTALLATION METHODS ① CONCRETE -Quantity of sonotube of 12"Øx12':6 CONCRETE -3.0 cu.m. (3.9cu.yd.)</p> 
<p>② SYSTÈME AUTO-PORTANT: Qté charpentes: NA Béton : - 0 m. cu. (0vge cu.)</p> 	<p>② FREE-STANDING SYSTEM: Frame QTY: NA Concrete: - 0 cu. m. (0 cu. yd.)</p> 
<p>Attention : AIRE DE CIRCULATION LIBRE: Aire dégagée d'obstacle qui se prolonge sur au moins 1.8m (70.87") au delà de la zone de protection. Voir dessin pour les détails.</p> 	<p>Warning: NO-ENCROACHMENT ZONE : Obstacle-free zone extending at least 1.8m (70.87") beyond the protective surfacing zone. See drawing for details.</p> 

<p>Ktheme-101Jg</p>	<p>Min. Protective Surface Required / Surface de protection min. requise 11m (34'-5") x 14 m (46'-5")</p>	<p>Equipment Dimensions / Dimensions de l'équipement : 10.4m (34'-4") x 6.5 m (21'-4")</p>	<p>Fall Height / Hauteur de chute: 2.29 m (7'-6")</p>	<p>Approval date: 26-08-20 Rev: 01 Initial: AK</p>
<p>CAN/CSA-Z614</p>	<p>Recommended Ages / Âges recommandés : 5 years to 12 years old / Sans à 12 ans</p>	<p>Capacity / Peut accueillir : up to 30 children / Jusqu'à 30 enfants</p>		