



23 ch. Boom Lane, Unit/Unité E
 Industrial Park/Parc industriel
 Atholville, New/Nouveau-Brunswick
 Canada, E3N 4E8
 Tel/tél. : 1-888-212-1411/Fax/télec. : 1-888-789-0987
 contact@kangoroo.com / www.kangoroo.com



Colors / Couleurs

Post / Poteaux: Red/Rouge

Accent Color / Couleur complémentaire:
 Cyan/Cyan

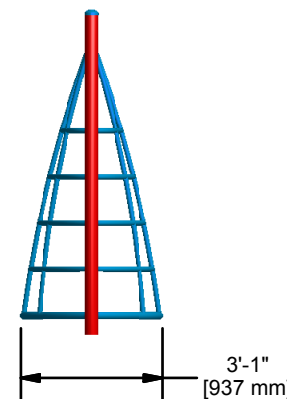
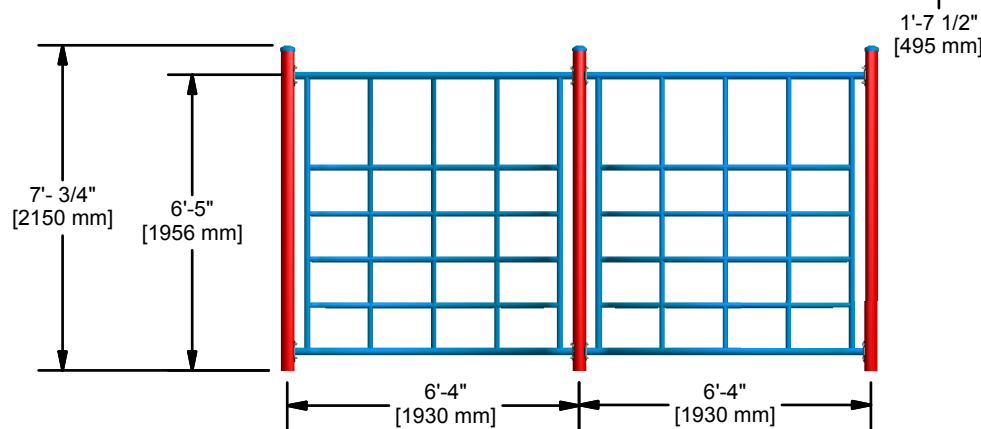
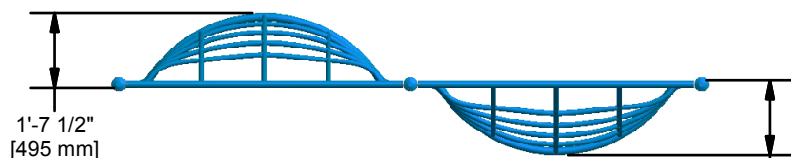
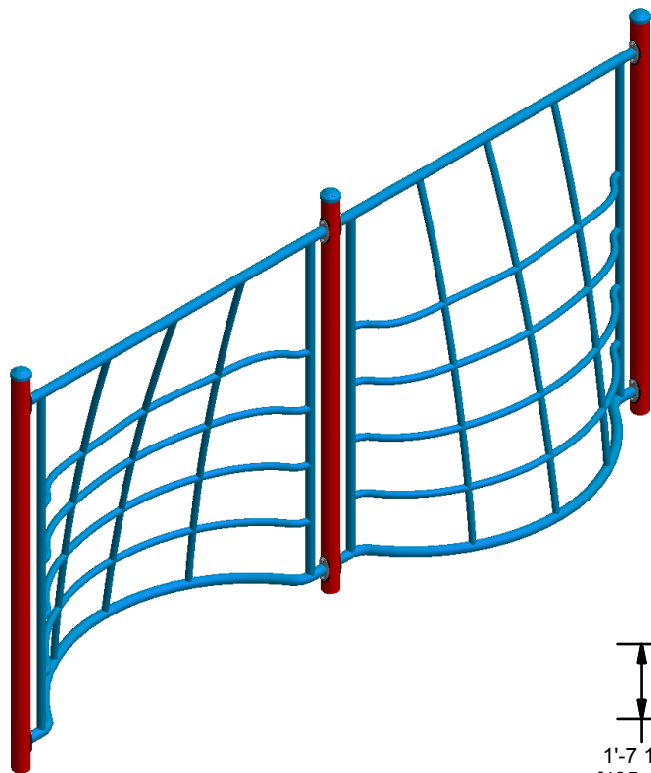

<p>SS-334</p>	<p>Min. Protective Surface Required / Surface de protection min. requise : 7.6 m (25'-0") x 4.6 m (15'-1")</p>	<p>Equipment Dimensions / Dimensions de l'équipement : 4.0 m (13'-0") x 0.9 m (3'-1")</p>	<p>Approval date: 05/02/2014 Rev: 00 Initial: TLG</p>
<p>CAN/CSA-Z614-xx xx: Last Edition Published/ Dernière édition publiée</p>	<p>Recommended Ages / Âges recommandés : 5 to 12 years old / 5 à 12 ans</p>	<p>Capacity / Peut accueillir : up to 10 children / Jusqu'à 10 enfants</p>	



23 ch. Boom Lane, Unit/Unité E, Industrial Park/Parc industriel
 Atholville, New/Nouveau-Brunswick
 Canada, E3N 4E8
 Tel/tél. : 1-888-212-1411 - Fax/télééc. : 1-888-789-0987
 contact@kangoroo.com / www.kangoroo.com

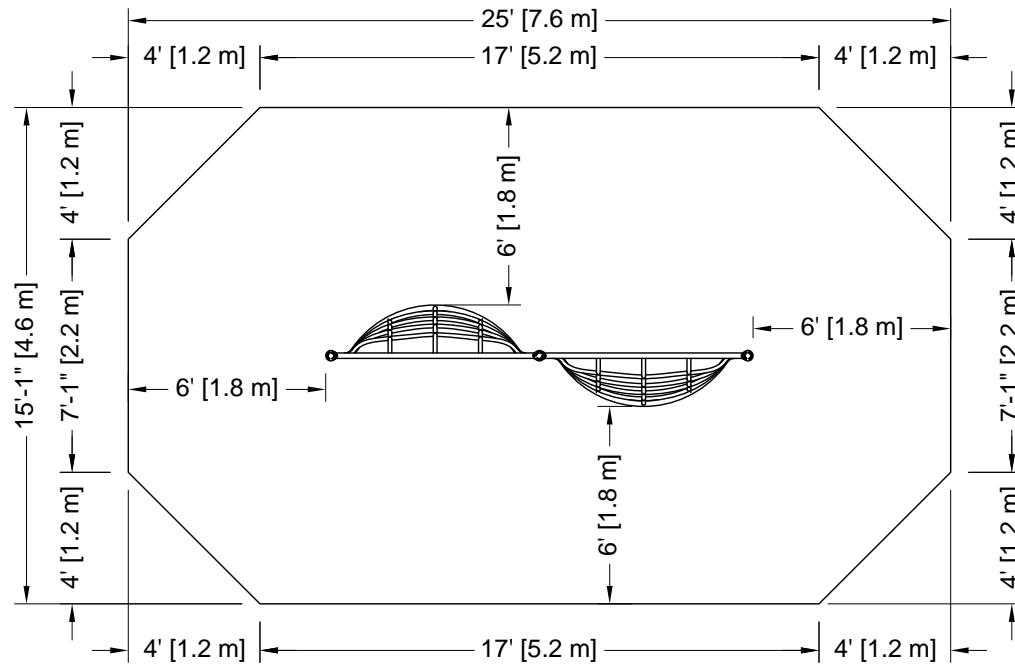

PLATFORM HEIGHTS
 HAUTEURS DE PLATEFORME

12" = 305MM	60" = 1524MM
24" = 609MM	72" = 1829MM
36" = 915MM	84" = 2134MM
48" = 1219MM	96" = 2438MM

ZONE DE PROTECTION:

Chaque équipement doit avoir une zone de protection constituée d'une surface sans obstacle qui se prolonge dans toutes les directions à partir du périmètre de l'équipement. Cette zone doit contenir un revêtement de surface (gravillon, sable, etc...) avec une capacité d'amortissement selon les normes CSA-Z614. Sauf avis contraire.

Zone de protection minimum requise:

$$7.6 \text{ m (25'-0")}$$

$$\times$$

$$4.6 \text{ m (15'-1")}$$

- Aire : 32.03 m ca. (344.83 pi. ca.)
- Périmètre : 21.6 m (71'-0")

PROTECTIVE SURFACING ZONE :

Each equipment shall have a protective surfacing zone that consist of obstacle-free surfacing surrounding the equipment. This zone shall contain shock absorbing materi: (pea gravel, sand, etc...) that comply with CSA-Z614. Unless noted otherwise.

Minimum

Protective Surfacing Zone required:

$$7.6 \text{ m (25'-0")}$$

$$\times$$

$$4.6 \text{ m (15'-1")}$$

- Surface: 32.03 sq. m (344.83 sq. ft.)
- Perimeter: 21.6 m (71'-0")

MÉTHODES D'INSTALLATION

INSTALLATION METHODE.

1

DANS LE BÉTON:

- Quantité de Sonotube de 12" Ø x 12' : 1

Béton :
 - 0.23 m. cu.
 (0.3 vge cu.)



1

CONCRETE:

- Quantity of Sonotube of 12" Ø x 12': 1

Concrete:
 - 0.23 cu. m.
 (0.3 cu. yd.)

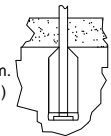

2

SYSTÈME AUTO-PORTANT:

Qté charpentes: 0
 Béton :
 - .23 m. cu.
 (0.3 vge cu.)



2

FREE-STANDING SYSTEM

Frame QTY: 0
 Concrete:
 - .23 cu. m.
 (0.3 cu. yd.)

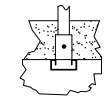

Attention :

AIRE DE CIRCULATION LIBRE:

Aire dégagée d'obstacle qui se prolonge sur au moins 1.8m (70.87") au delà de la zone de protection. Voir dessin pour les détails.

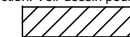

Warning:

NO-ENCROACHMENT ZONE

Obstacle-free zone extending at least 1.8m (70.87") beyond the protective surfacing zone. See drawing for details.



SS-334

Equipment Dimensions / Dimensions de l'équipement :
 4.0 m (13'-0") x 0.9 m (3'-1")

Recommended Ages / Âges recommandés :

5 to 12 years old
 5 à 12 ans

CAN/CSA-Z614-xx
 xx: Last Edition Published /
 Dernière édition publiée

Capacity / Peut accueillir :
 up to 10 children / Jusqu'à 10 enfants

Fall Height /
 Hauteur de chute:
 1.96 m (6'-5")

Approval date: 05-02-2014

Rev: 00
 Initial: TLG

