



23 ch. Boom Lane, Unit/Unité E, Industrial Park/Parc industriel  
 Atholville, New-Brunswick, Canada, E3N 4E8  
 Tel/tél. : 1-888-212-1411, Fax. : 1-888-789-0987  
 contact@kangaroo.com / www.kangaroo.com



### Colors / Couleurs

Post / Poteaux: White/Blanc

Accent Color / Couleur complémentaire:  
 Blue & Red/Rouge et bleu

1 Color panel / Panneaux 1 couleur: Red/rouge

2 colors panel / Panneaux 2 couleurs :  
 Blue & White/Rouge et blanc

Slide / Glissoire: Red/Rouge

Plastic Climbers / Grimpeur Plastique:  
 NA

Cable / Cable : NA

Roof / Toit : NA

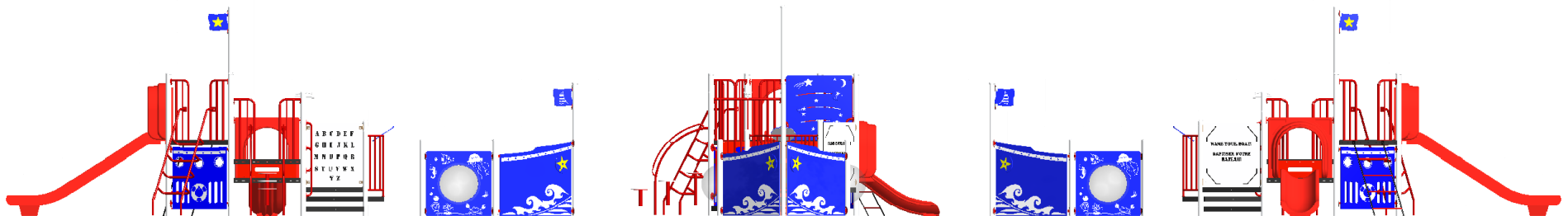
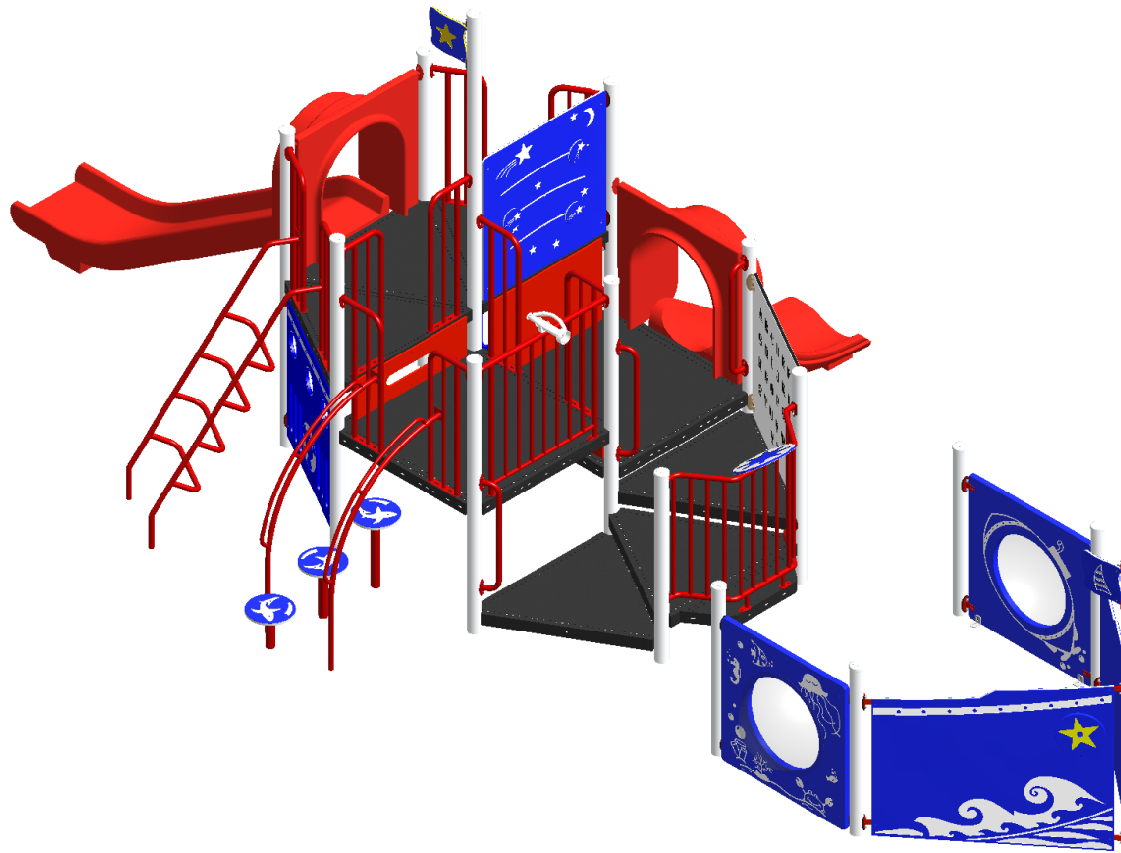

### Kthème-105Bt

Min. Protective Surface Required / Surface de protection min. requise :  
 12.8 m (42'-1") x 8.6 m (28'-3")

Equipment Dimensions / Dimensions de l'équipement :  
 9.2 m (30'-1") x 4.9 m (16'-3")

Approval date: 21/02/2017

Rev: 00

Initial: TLG

CAN/CSA-Z614-xx  
 xx: Last Edition Published/  
 Dernière édition publiée

Recommended Ages / Âges recommandés :  
 18 months to 5 years old / 18 mois à 5 ans

Capacity / Peut accueillir :  
 up to 30 children / Jusqu'à 30 enfants





23 ch. Boom Lane, Unit/Unité E  
 Industrial Park/Parc industriel  
 Atholville, New/Novveau-Brunswick  
 Canada, E3N 4E8  
 Tel/tél. : 1-888-212-1411/Fax/télééc. : 1-888-789-0987  
 www.kangaroo.com

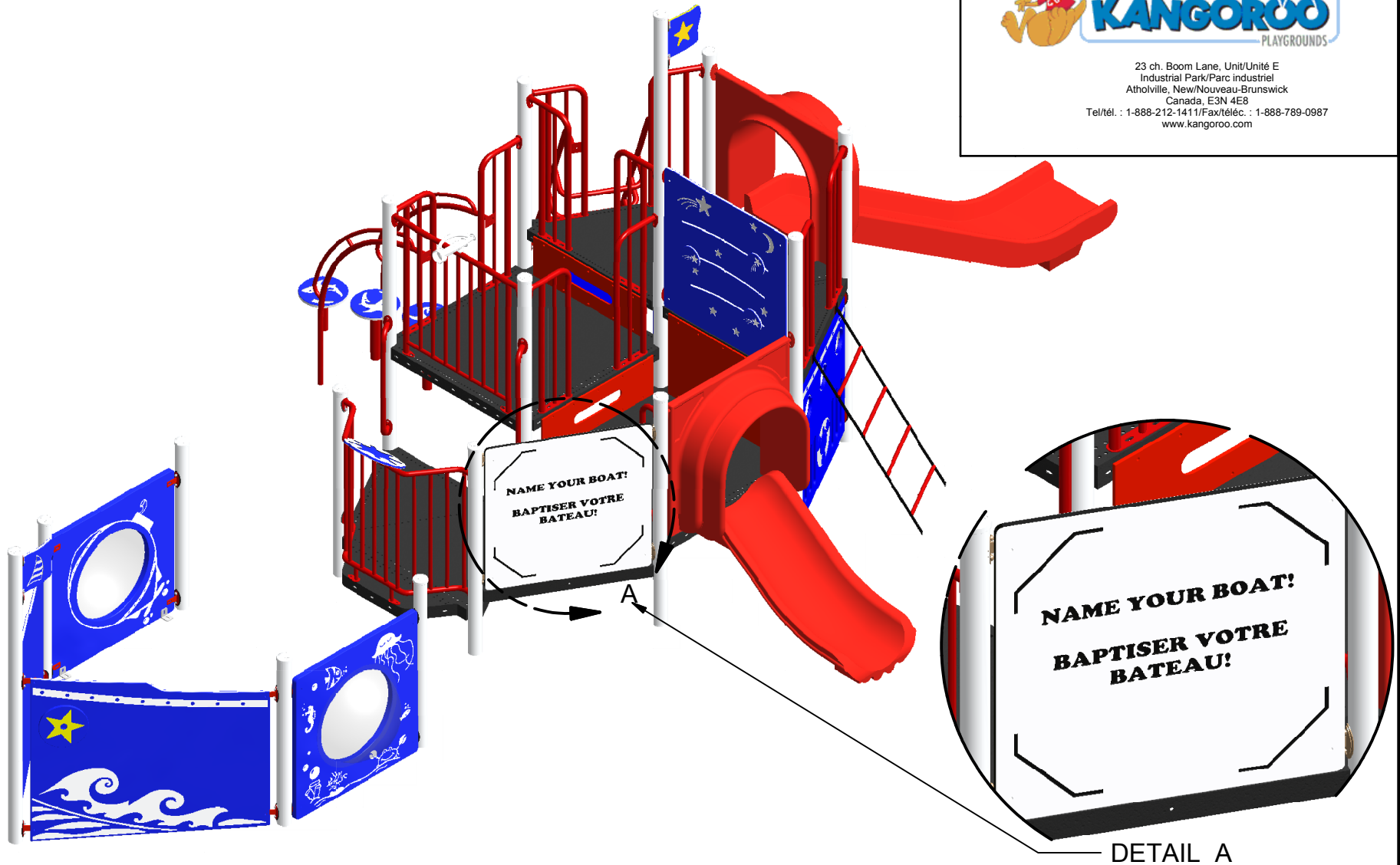

|  |   |  |   |
|--|---|--|---|
| <b>Ktheme-105Bt</b>  | Min. Protective Surface Required / Surface de protection min. requise :<br>12.8 m (42'-1") x 8.6 m (28'-3") | Equipment Dimensions / Dimensions de l'équipement :<br>9.2 m (30'-1") x 4.9 m (16'-3") | Approval date: 21/02/2017<br>Rev: 00<br>Initial: TLG                                  |
| CAN/CSA-Z614-xx<br>xx: Last Edition Published/<br>Dernière édition publiée | Recommended Ages / Âges recommandés :<br>18 months to 5 years old / 18 mois à 5 ans                         | Capacity / Peut accueillir :<br>up to 30 children / Jusqu'à 30 enfants                 |  |



23 ch. Boom Lane, Unit/Unité E  
 Industrial Park/Parc industriel  
 Atholville, New/Nouveau-Brunswick  
 Canada, E3N 4E8  
 Tel/tél. : 1-888-212-1411/Fax/télééc. : 1-888-789-0987  
 www.kangaroo.com

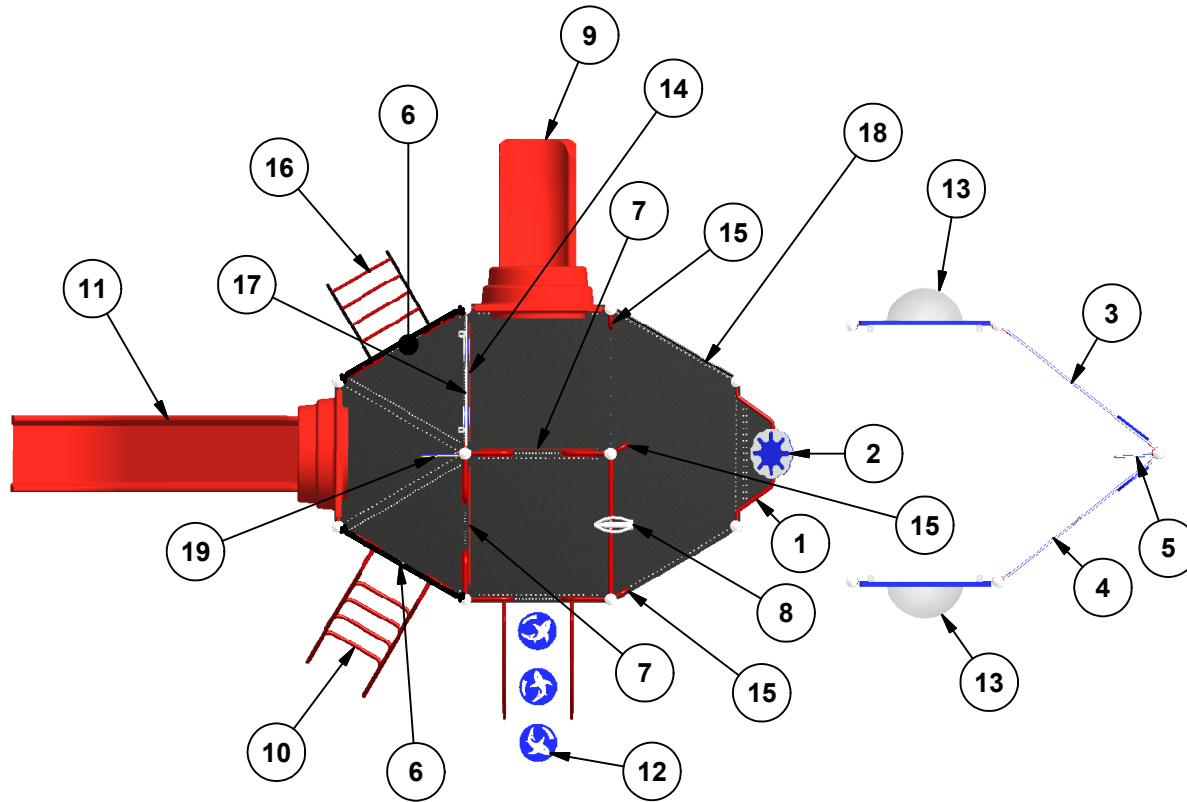

Legend / Légende

| ITEM | QTY | Description  | PART # / # PIECE |
|------|-----|--|------------------|
| 1    | 1   | Balcony Deck / Balcon  | PF-BD            |
| 2    | 1   | Small Ship Wheel / Petit gouvernail  | SHIP-WHEEL       |
| 3    | 1   | KG Right Boat Bow/Coque de bateau droite<br>KG                             | KG-RGHT-BT-BOW   |
| 4    | 1   | KG Left Boat Bow/Coque de bateau gauche<br>KG                              | KG-LFT-BT-BOW    |
| 5    | 1   | Nautica Flague / Drapeau nautique  | FLAGUE           |
| 6    | 2   | KG Buoy Panel / Panneau bouée KG   | KG-BUOY          |
| 7    | 2   | Riser 12"/contre-marche 12"  | Riser-12         |
| 8    | 1   | Telescope Panel / Panneau télescope  | AC-TELE          |
| 9    | 1   | Double Wall Slide 24" / Glissoire simple 24"                               | FS-2DWFS         |
| 10   | 1   | Inclined Half Loop Climber 48" / Grimpeur à<br>demi-boucles incliné 48"    | FS-IHLO-CL-48    |
| 11   | 1   | Double Wall Slide 48" / Glissoire simple 48"                               | FS-4DWFS         |
| 12   | 1   | Shark Pod Climber 36" / Grimpeur Requin 36"                                | FS-SHRK-PD-36    |
| 13   | 2   | KG Bubble / Bulle KG   | KG-Bub24         |
| 14   | 1   | Security Panel/Panneau de sécurité   | Riser-24         |
| 15   | 3   | Transfer support / Support de transfer                                     | R10P             |
| 16   | 1   | Ship Ladder 48"/ Echelle de bateau 48"                                     | FS-SHIP-LA-48    |
| 17   | 1   | KG Weather Station / Panneau météo KG                                      | KG-WTHR          |
| 18   | 1   | KG Alphabet Panel (CUSTOM WRITTING)/<br>Panneau alphabet KG (PERSONNALISÉ) | KG-Alpha-C       |
| 19   | 1   | Star Flague / Drapeau étoile   | FLAGUE-ST        |

**Kthème-105Bt**

Min. Protective Surface Required / Surface de protection min. requise :  
 12.8 m (42'-1") x 8.6 m (28'-3")

Equipment Dimensions / Dimensions de l'équipement :  
 9.2 m (30'-1") x 4.9 m (16'-3")

Approval date: 21/02/2017

Rev: 00

Initial: TLG

CAN/CSA-Z614-xx  
 xx: Last Edition Published/  
 Dernière édition publiée

Recommended Ages / Âges recommandés :  
 18 months to 5 years old / 18 mois à 5 ans

Capacity / Peut accueillir :  
 up to 30 children / Jusqu'à 30 enfants





23 ch. Boom Lane, Unit/Unité E, Industrial Park/Parc industriel  
 Atholville, New/Nouveau-Brunswick  
 Canada, E3N 4E8  
 Tel/tél. : 1-888-212-1411 - Fax/télec. : 1-888-789-0987  
 contact@kangoroo.com / www.kangoroo.com

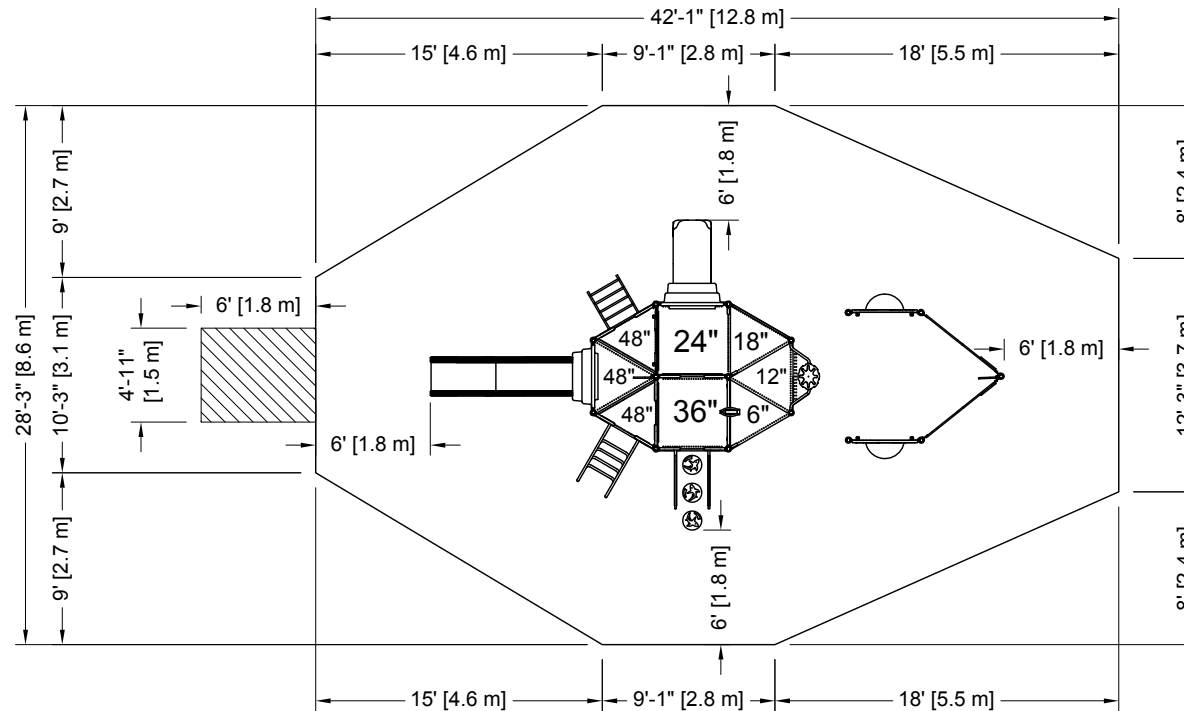

PLATFORM HEIGHTS  
 HAUTEURS DE PLATEFORME

|              |              |
|--------------|--------------|
| 6" = 152MM   | 60" = 1524MM |
| 12" = 305MM  | 72" = 1829MM |
| 18" = 457MM  | 84" = 2134MM |
| 24" = 609MM  | 96" = 2438MM |
| 36" = 915MM  |              |
| 48" = 1219MM |              |



**ZONE DE PROTECTION:**

Chaque équipement doit avoir une zone de protection constituée d'une surface sans obstacle qui se prolonge dans toutes les directions à partir du périmètre de l'équipement. Cette zone doit contenir un revêtement de surface (gravillon, sable, etc...) avec une capacité d'amortissement selon les normes CSA-Z614. Sauf avis contraire.

**Zone de protection minimum requise:**

$$12.8 \text{ m (42'-1")}$$

$$\times$$

$$8.6 \text{ m (28'-3")}$$

- Aire : 84.34 m ca. (907.89 pi. ca.)
- Périmètre : 35.06 m (115'-0")

**PROTECTIVE SURFACING ZONE :**

Each equipment shall have a protective surfacing zone that consist of obstacle-free surfacing surrounding the equipment. This zone shall contain shock absorbing material (pea gravel, sand, etc...) that comply with CSA-Z614. Unless noted otherwise.

**Minimum Protective Surfacing Zone required:**

$$12.8 \text{ m (42'-1")}$$

$$\times$$

$$8.6 \text{ m (28'-3")}$$

- Surface: 84.34 sq. m (907.89 sq. ft.)
- Perimeter: 35.06 m (115'-0")

**MÉTHODES D'INSTALLATION**

1

**DANS LE BÉTON:**

- Quantité de Sonotube de 12" Ø x 12' : 3

Béton :  
 - 1.14 m. cu.  
 ( 1.5 vge cu.)



1

**CONCRETE:**

- Quantity of Sonotube of 12" Ø x 12': 3

Concrete:  
 - 1.14 cu. m.  
 (1.5 cu. yd.)

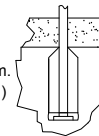

2

**SYSTÈME AUTO-PORTANT:**

Qté charpentes: 5  
 Béton :  
 - 0.46 m. cu.  
 (0.6 vge cu.)

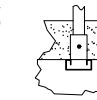

2

**FREE-STANDING SYSTEM**

Frame QTY: 5  
 Concrete:  
 - 0.46 cu. m.  
 (0.6 cu. yd.)

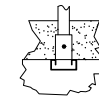

**Attention :**

**AIRE DE CIRCULATION LIBRE:**

Aire dégagée d'obstacle qui se prolonge sur au moins 1.8m (70.87") au delà de la zone de protection. Voir dessin pour les détails.

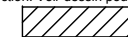

**Warning:**

**NO-ENCROACHMENT ZONE**

Obstacle-free zone extending at least 1.8m (70.87") beyond the protective surfacing zone. See drawing for details.



**Kthème-105Bt**

CAN/CSA-Z614-xx  
 xx: Last Edition Published /  
 Dernière édition publiée

Equipment Dimensions / Dimensions de l'équipement :  
 9.2 m (30'-1") x 4.9 m (16'-3")

Capacity / Peut accueillir :  
 up to 30 children / Jusqu'à 30 enfants

Recommended Ages / Âges recommandés :  
 18 months to 5 years old  
 18 mois à 5 ans

Fall Height /  
 Hauteur de chute:  
 2.29 m (7'-6")

Approval date: 21-02-2017  
 Rev: 00  
 Initial: TLG

