



23 ch. Boom Lane, Unit/Unité E  
 Industrial Park/Parc industriel  
 Atholville, New/Nouveau-Brunswick  
 Canada, E3N 4E8  
 Tel/tél. : 1-888-212-1411/Fax/télec. : 1-888-789-0987  
 contact@kangaroo.com / www.kangaroo.com

### Colors / Couleurs

Post / Poteaux: Blue/Bleu

Accent Color / Couleur complémentaire:  
 Yellow/Jaune

1 Color panel / Panneaux 1 couleur: Blue/Bleu

2 colors panel / Panneaux 2 couleurs :  
 Red & Blue/Rouge et Bleu

Slide / Glissoire: Silver Blue/Bleu argenté

Plastic Climbers / Grimpeur Plastique:  
 NA

Cable / Cable : NA

Roof / Toît : Red/Rouge



### Kkids-147M1

Min. Protective Surface Required / Surface de protection min. requise :  
 12.5 m (40'-11") x 10.4 m (34'-0")

Equipment Dimensions / Dimensions de l'équipement :  
 8.8 m (28'-11") x 6.7 m (22'-0")

Approval date: 04/08/2015

Rev: 00

Initial: TLG

CAN/CSA-Z614-xx  
 xx: Last Edition Published/  
 Dernière édition publiée

Recommended Ages / Âges recommandés :  
 18 months to 12 years old / 18 mois à 12 ans

Capacity / Peut accueillir :  
 up to 40 children / Jusqu'à 40 enfants





23 ch. Boom Lane, Unit/Unité E  
 Industrial Park/Parc industriel  
 Atholville, New/Novéau-Brunswick  
 Canada, E3N 4E8  
 Tel/tél. : 1-888-212-1411/Fax/télééc. : 1-888-789-0987  
 www.kangaroo.com

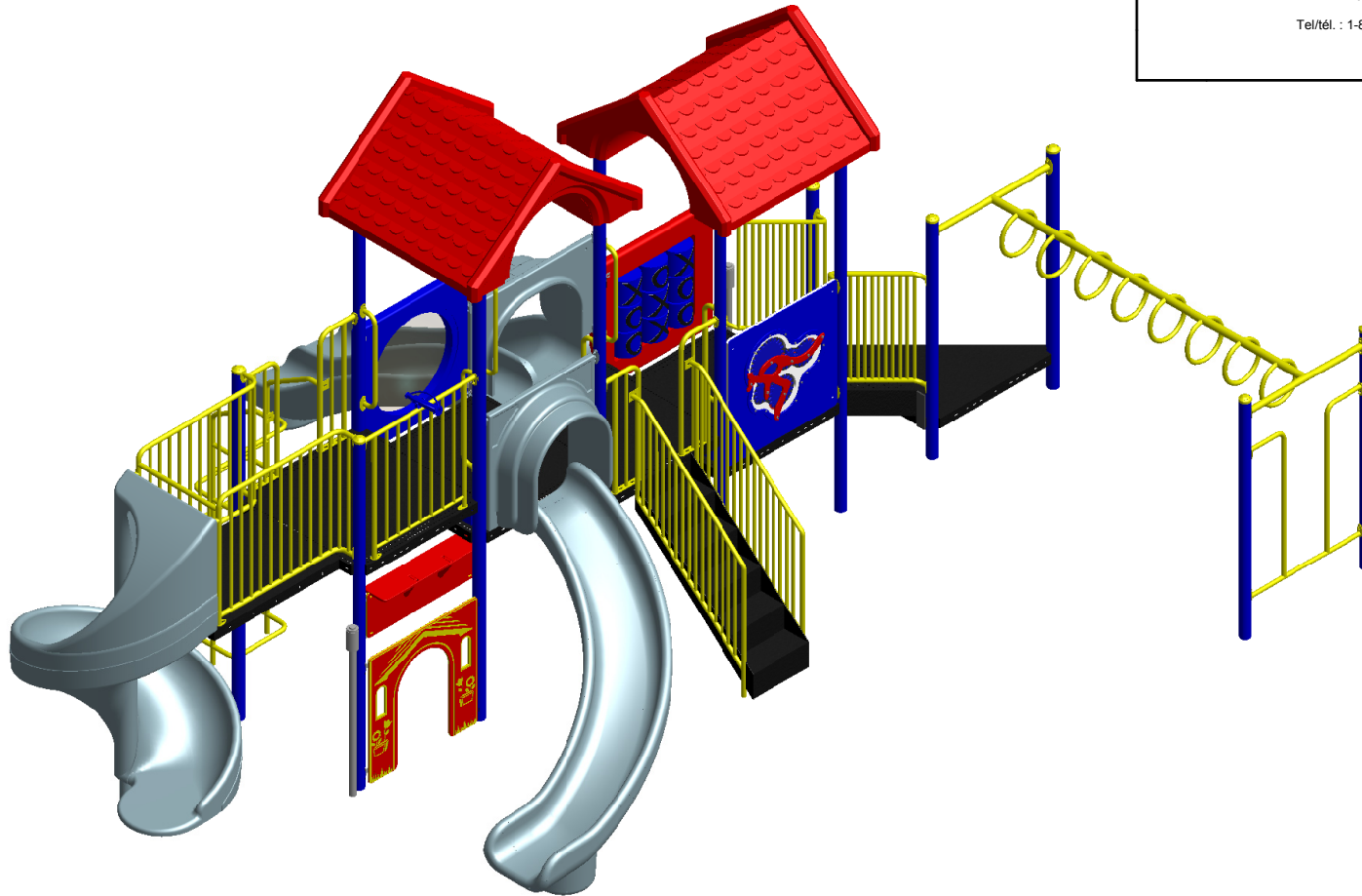

<b>Kkids-147M1</b>	Min. Protective Surface Required / Surface de protection min. requise : 12.5 m (40'-11") x 10.4 m (34'-0")	Equipment Dimensions / Dimensions de l'équipement : 8.8 m (28'-11") x 6.7 m (22'-0")	Approval date: 04/08/2015 Rev: 00 Initial: TLG
CAN/CSA-Z614-xx xx: Last Edition Published/ Dernière édition publiée	Recommended Ages / Âges recommandés : 18 months to 12 years old / 18 mois à 12 ans	Capacity / Peut accueillir : up to 40 children / Jusqu'à 40 enfants	



23 ch. Boom Lane, Unit/Unité E  
 Industrial Park/Parc industriel  
 Atholville, New/Nouveau-Brunswick  
 Canada, E3N 4E8  
 Tel/tél. : 1-888-212-1411/Fax/télééc. : 1-888-789-0987  
 www.kangoroo.com

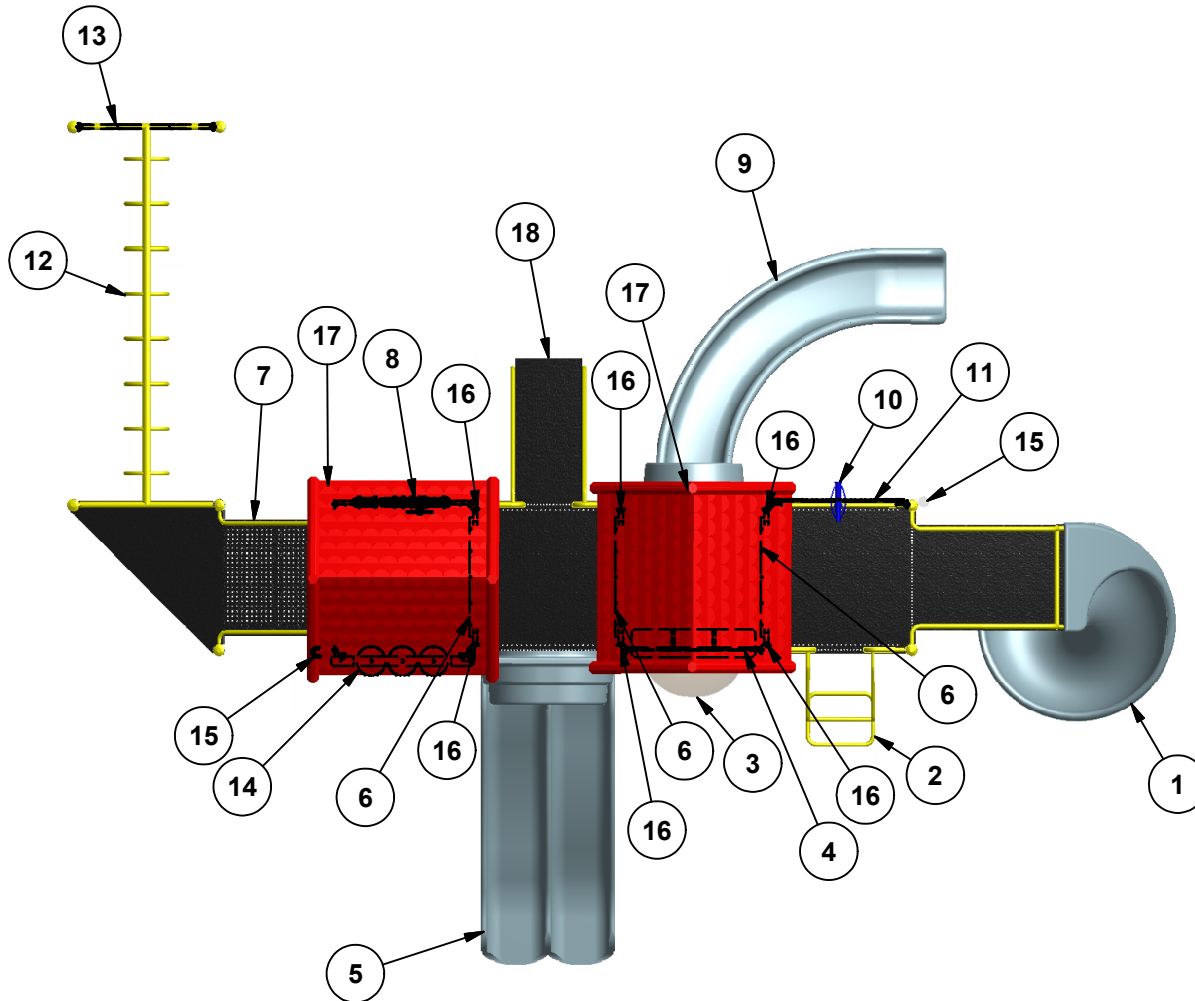

Legend / Légende

ITEM	QTY	Description	PART # / # PIECE
1	1	Open Spiral Slide 72" / Glissoire Spirale 72"	FS-SPI-SL-72
2	1	Loop Climber 72" / Échelle à boucles 72"	FS-LO-CL-72
3	1	Bubble Panel / Panneau Bulle	AC-BUB
4	1	KG Counter Panel/Panneau comptoir KG	KG-Counter
5	1	Triple Rail Slide 48" / Glissoire double 48"	4TRS
6	3	Riser 12" / Contre-marche 12"	RISER-12
7	1	Transfer Stairs 36"/Marches accessibles 36"	TRANST-36
8	1	KG Gear Panel / Panneau d'engrenages KG	KG-Gear
9	1	Curved Slide 60"H / Glissoire Courbée 60"H	5CURVED
10	1	Telescope Panel / Panneau télescope	AC-TELE
11	1	KG House Entrance / Entrée de maisonnette KG	KG-House
12	1	Fixed Ring Ladder / Échelle à anneaux immobiles	SS-329
13	1	Handle Ladder / Échelle d'accès	HL02
14	1	Tic-Tac-Toe Panel / Panneau tic-tac-toe	AC-TTT
15	2	Talk Tube / Téléphone	T-123A
16	6	Transfer support / Support de transfert	R10P
17	2	Gable Roof / Toit à pignon	GABLEROOF
18	1	Stairs 48" / Escaliers 48"	STAIR-48

**Kkids-147M1**

Min. Protective Surface Required / Surface de protection min. requise :  
 12.5 m (40'-11") x 10.4 m (34'-0")

Equipment Dimensions / Dimensions de l'équipement :  
 8.8 m (28'-11") x 6.7 m (22'-0")

Approval date: 04/08/2015  
 Rev: 00

CAN/CSA-Z614-xx  
 xx: Last Edition Published/  
 Dernière édition publiée

Recommended Ages / Âges recommandés :  
 18 months to 12 years old / 18 mois à 12 ans

Capacity / Peut accueillir :  
 up to 40 children / Jusqu'à 40 enfants

Initial: TLG





23 ch. Boom Lane, Unit/Unité E, Industrial Park/Parc industriel  
 Atholville, New/Nouveau-Brunswick  
 Canada, E3N 4E8  
 Tel/tél. : 1-888-212-1411 - Fax/télééc. : 1-888-789-0987  
 contact@kangoroo.com / www.kangoroo.com

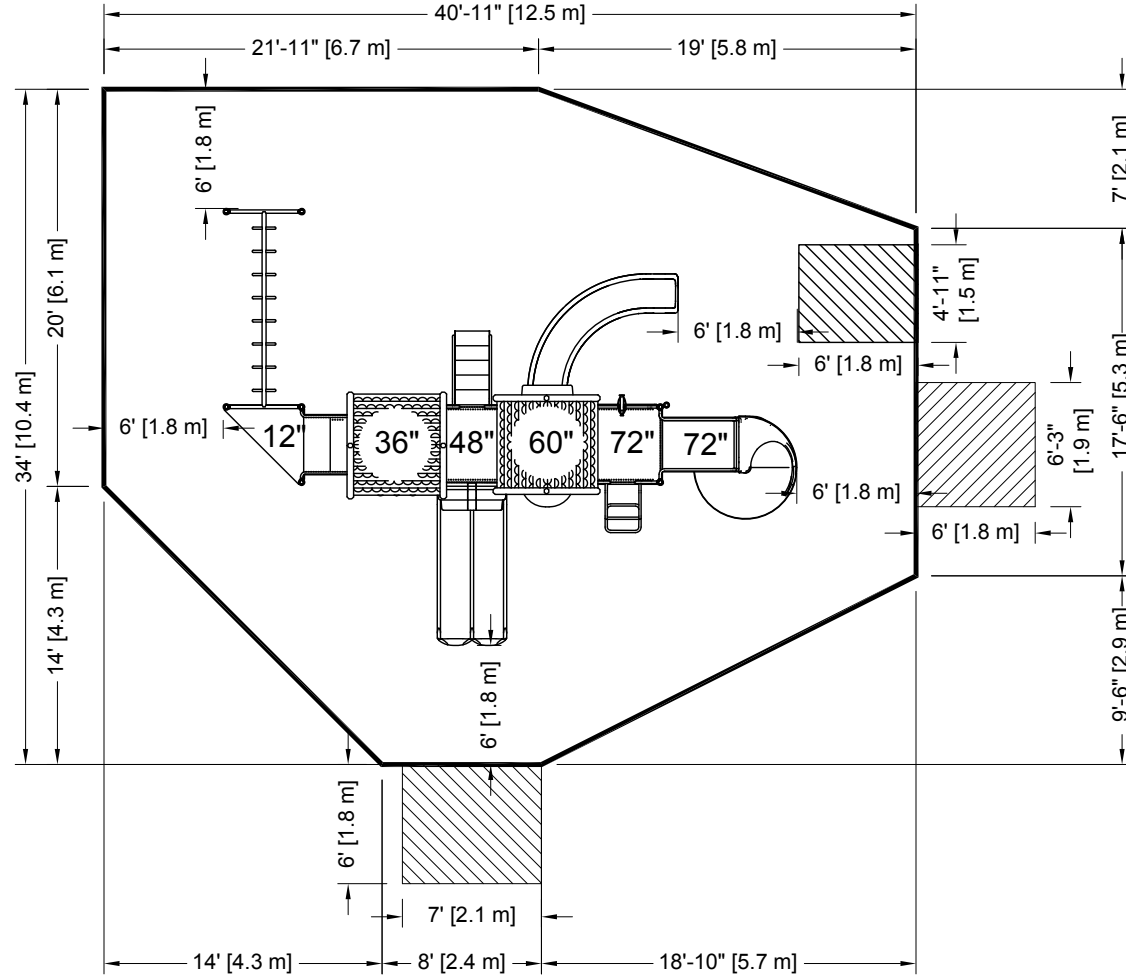

**PLATFORM HEIGHTS**  
**HAUTEURS DE PLATEFORME**

12" = 305MM	60" = 1524MM
24" = 609MM	72" = 1829MM
36" = 915MM	84" = 2134MM
48" = 1219MM	96" = 2438MM

**ZONE DE PROTECTION:**

Chaque équipement doit avoir une zone de protection constituée d'une surface sans obstacle qui se prolonge dans toutes les directions à partir du périmètre de l'équipement. Cette zone doit contenir un revêtement de surface (gravillon, sable, etc...) avec une capacité d'amortissement selon les normes CSA-Z614. Sauf avis contraire.

**Zone de protection minimum requise:**

$$12.5 \text{ m (40'-11")}$$

$$\times$$

$$10.4 \text{ m (34'-0")}$$

- Aire : 105.51 m ca. (1135.76 pi. ca.)
- Périmètre : 39.33 m (129'-0")

**PROTECTIVE SURFACING ZONE :**

Each equipment shall have a protective surfacing zone that consist of obstacle-free surfacing surrounding the equipment. This zone shall contain shock absorbing material (pea gravel, sand, etc...) that comply with CSA-Z614. Unless noted otherwise.

**Minimum Protective Surfacing Zone required:**

$$12.5 \text{ m (40'-11")}$$

$$\times$$

$$10.4 \text{ m (34'-0")}$$

- Surface: 105.51 sq. m (1135.76 sq. ft)
- Perimeter: 39.33 m (129'-0")

**MÉTHODES D'INSTALLATION**

1

**DANS LE BÉTON:**

- Quantité de Sonotube de 12" Ø x 12" : 4

Béton :  
 - 1.44 m. cu. (1.9 vge cu.)



1

**CONCRETE:**

- Quantity of Sonotube of 12" Ø x 12": 4

Concrete:  
 - 1.44 cu. m. (1.9 cu. yd.)

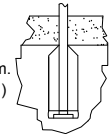

2

**SYSTÈME AUTO-PORTANT:**

Qté charpentes: 8

Béton :  
 - 0.31 m. cu. (0.4 vge cu.)

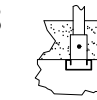

2

**FREE-STANDING SYSTEM**

Frame QTY: 8

Concrete:  
 - 0.31 cu. m. (0.4 cu. yd.)

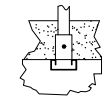

**Attention :**

**AIRE DE CIRCULATION LIBRE:**

Aire dégagée d'obstacle qui se prolonge sur au moins 1.8m (70.87") au delà de la zone de protection. Voir dessin pour les détails.

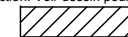

**Warning:**

**NO-ENCROACHMENT ZONE**

Obstacle-free zone extending at least 1.8m (70.87") beyond the protective surfacing zone. See drawing for details.



**Kkids-147M1**

CAN/CSA-Z614-xx  
 xx: Last Edition Published /  
 Dernière édition publiée

Equipment Dimensions / Dimensions de l'équipement :  
 8.8 m (28'-11") x 6.7 m (22'-0")

Capacity / Peut accueillir :  
 up to 40 children / Jusqu'à 40 enfants

Recommended Ages / Âges recommandés :  
 18 months to 12 years old  
 18 mois à 12 ans

Fall Height /  
 Hauteur de chute:  
 2.89 m (9'-6")

Approval date: 21-05-2015  
 Rev: 00  
 Initial: TLG

